

H_1

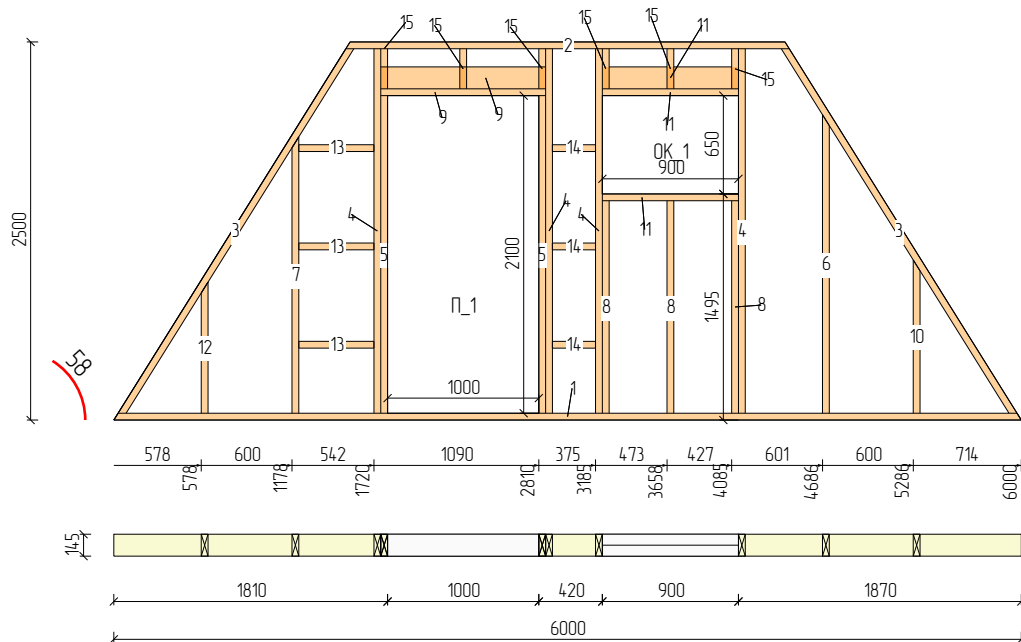

N	Марк	Сечение	Длина	Кол
1.	K1_01	145x45	6000	1
2.	K1_04	145x45	2932	1
3.	K1_05	145x45	2870	2
4.	K1_09	145x45	2410	4
5.	K1_10	145x45	2100	2
6.	K1_13	145x45	1974	1
7.	K1_17	145x45	1827	1
8.	K1_21	145x45	1405	3
9.	K1_24	145x45	1090	2
10.	K1_25	145x45	1014	1
11.	K1_27	145x45	900	3
12.	K1_28	145x45	867	1
13.	K1_36	145x45	496	3
14.	K1_41	145x45	285	3
15.	K1_42	145x45	265	6
Итого:		145x45	47,2м	34

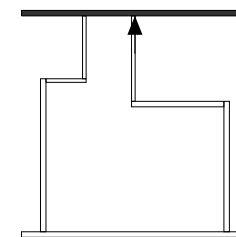
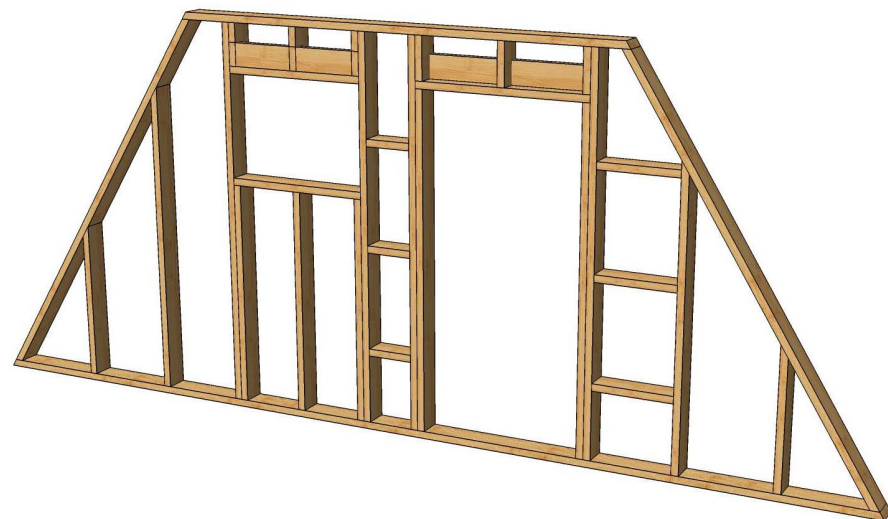

Лист 2

Лист

2

H_2

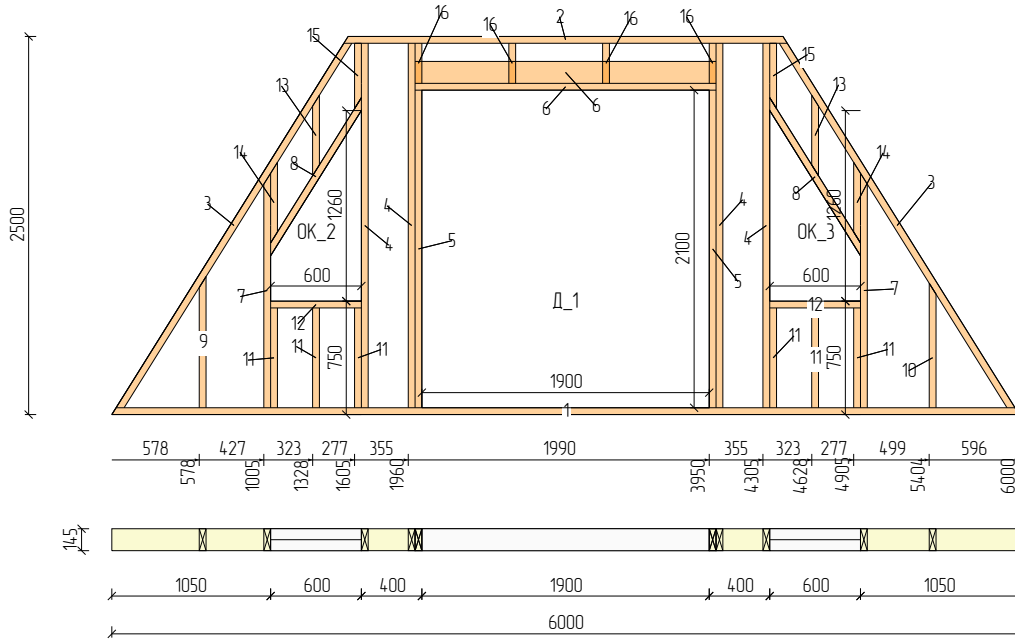

N	Марк	Сечение	Длина	Кол
1.	K1_01	145x45	6000	1
2.	K1_04	145x45	2932	1
3.	K1_05	145x45	2870	2
4.	K1_09	145x45	2410	4
5.	K1_10	145x45	2100	2
6.	K1_12	145x45	1990	2
7.	K1_20	145x45	1550	2
8.	K1_22	145x45	1204	2
9.	K1_28	145x45	867	1
10.	K1_30	145x45	823	1
11.	K1_31	145x45	660	6
12.	K1_32	145x45	600	2
13.	K1_33	145x45	533	2
14.	K1_34	145x45	532	2
15.	K1_37	145x45	432	2
16.	K1_42	145x45	265	4
Итого:		145x45	48,9м	36

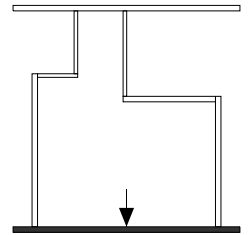
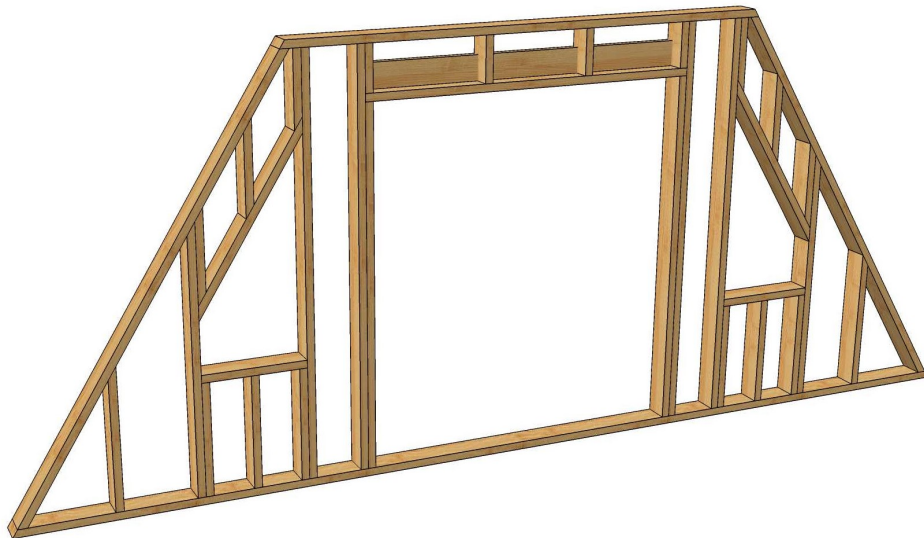

H_3

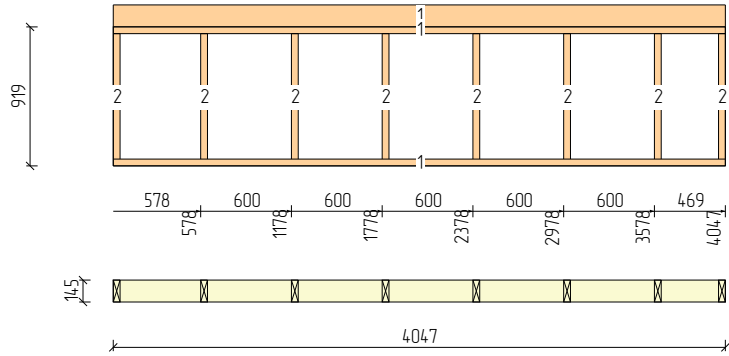

N	Марк	Сечение	Длина	Кол
1.	K1_02	145x45	4047	3
2.	K1_29	145x45	829	8
Итого:		145x45	18,8м	11

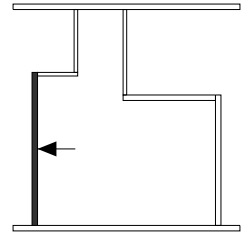
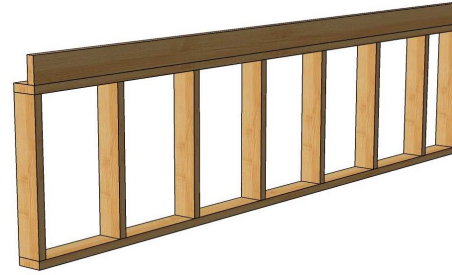

H_5

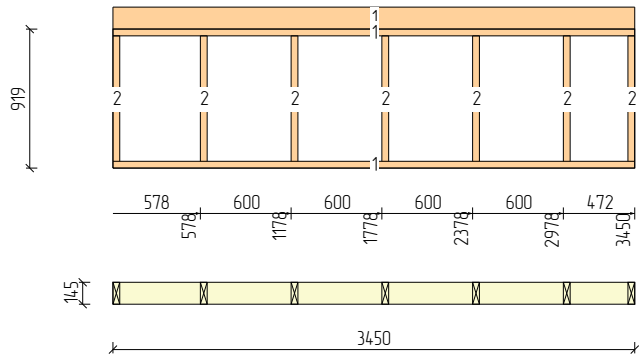

N	Марк	Сечение	Длина	Кол
1.	K1_03	145x45	3450	3
2.	K1_29	145x45	829	7
Итого:		145x45	16,2м	10

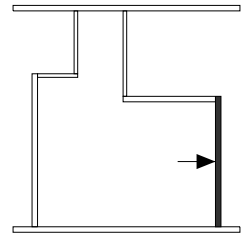
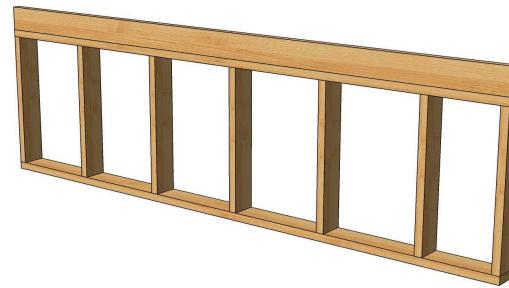

H_4

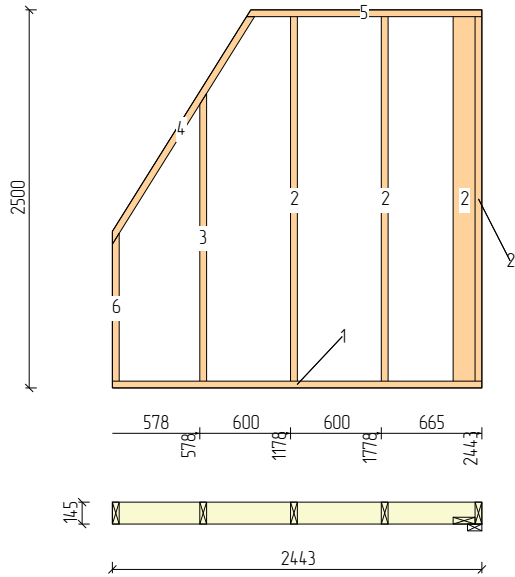

N	Марк	Сечение	Длина	Кол
1.	K1_08	145x45	2443	1
2.	K1_09	145x45	2410	4
3.	K1_14	145x45	1902	1
4.	K1_18	145x45	1774	1
5.	K1_19	145x45	1556	1
6.	K1_26	145x45	978	1
Итого:		145x45	18,3м	9

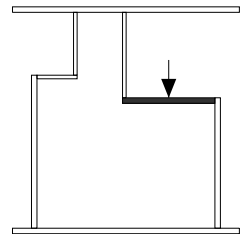

Лист 5

Лист

5

H_6

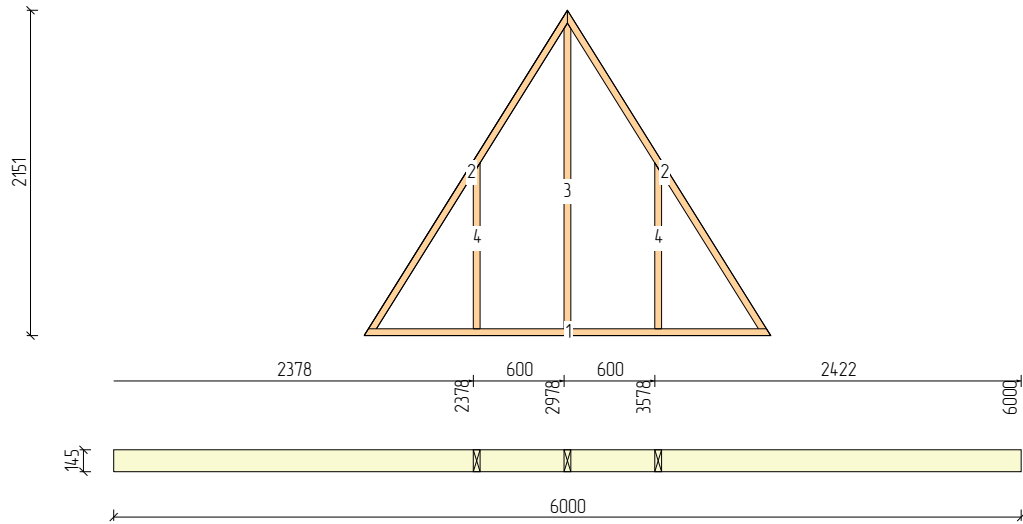

N	Марк	Сечение	Длина	Кол
1.	K1_06	145x45	2688	1
2.	K1_07	145x45	2483	2
3.	K1_11	145x45	2021	1
4.	K1_23	145x45	1097	2
Итого:		145x45	11,9м	6

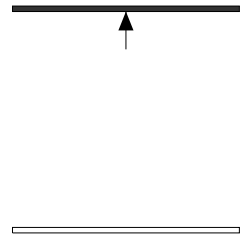

H_7

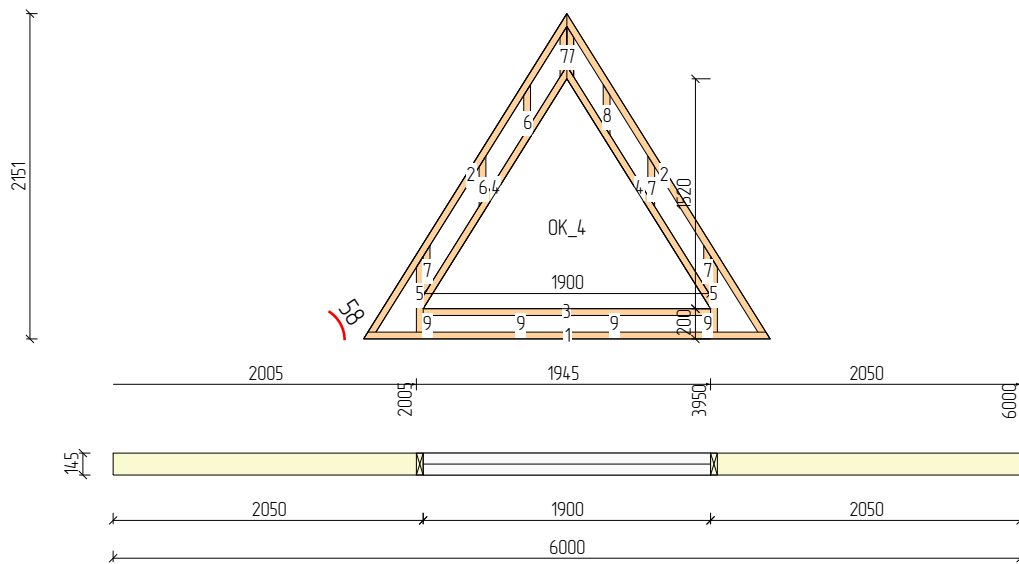

N	Марк	Сечение	Длина	Кол
1.	K1_06	145x45	2688	1
2.	K1_07	145x45	2483	2
3.	K1_15	145x45	1900	1
4.	K1_16	145x45	1864	2
5.	K1_35	145x45	501	2
6.	K1_38	145x45	334	2
7.	K1_39	145x45	333	5
8.	K1_40	145x45	332	1
9.	K1_43	145x45	110	4
Итого:		145x45	17,4м	20

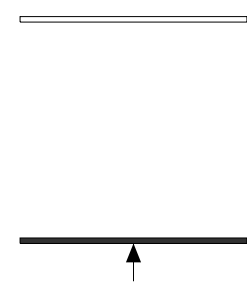
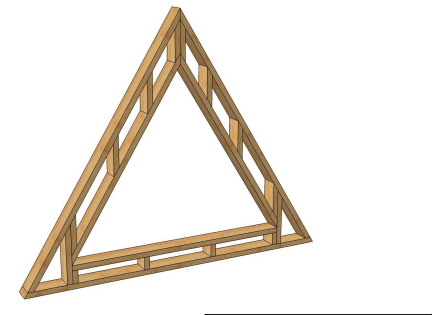

П_1

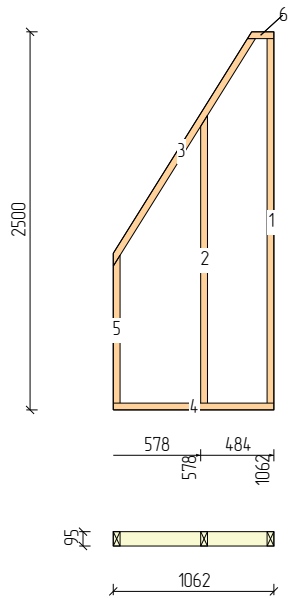

N	Марк	Сечение	Длина	Кол
1.	K2_01	95x45	2410	1
2.	K2_04	95x45	1902	1
3.	K2_05	95x45	1774	1
4.	K2_08	95x45	1062	1
5.	K2_09	95x45	978	1
6.	K2_12	95x45	175	1
Итого:		95x45	8,3м	6

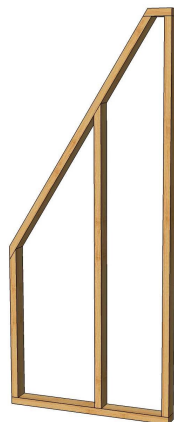
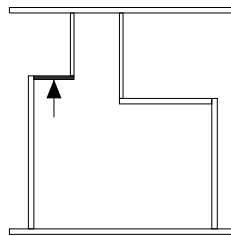

П_2

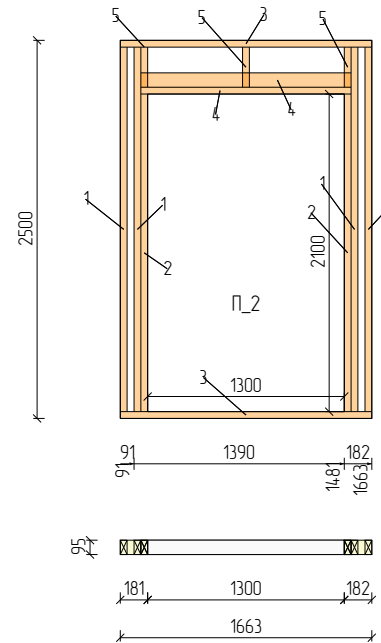

N	Марк	Сечение	Длина	Кол
1.	K2_01	95x45	2410	4
2.	K2_03	95x45	2100	2
3.	K2_06	95x45	1663	2
4.	K2_07	95x45	1390	2
5.	K2_11	95x45	265	3
Итого:		95x45	20,7м	13

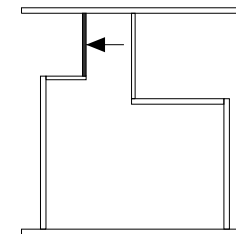

П_3

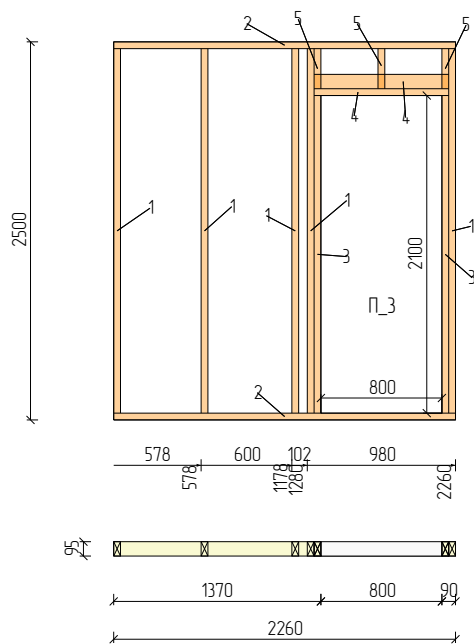

N	Марк	Сечение	Длина	Кол
1.	K2_01	95x45	2410	5
2.	K2_02	95x45	2260	2
3.	K2_03	95x45	2100	2
4.	K2_10	95x45	890	2
5.	K2_11	95x45	265	3
Итого:		95x45	23,3м	14

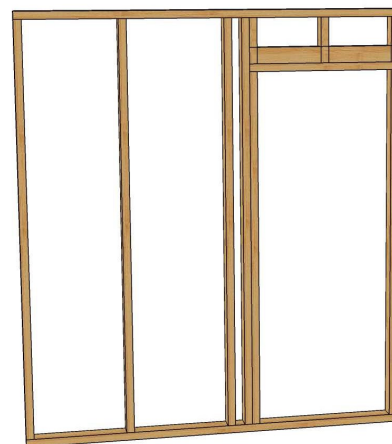
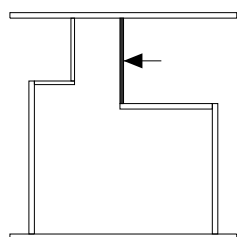

Лист 7

Лист

7